

Classroom

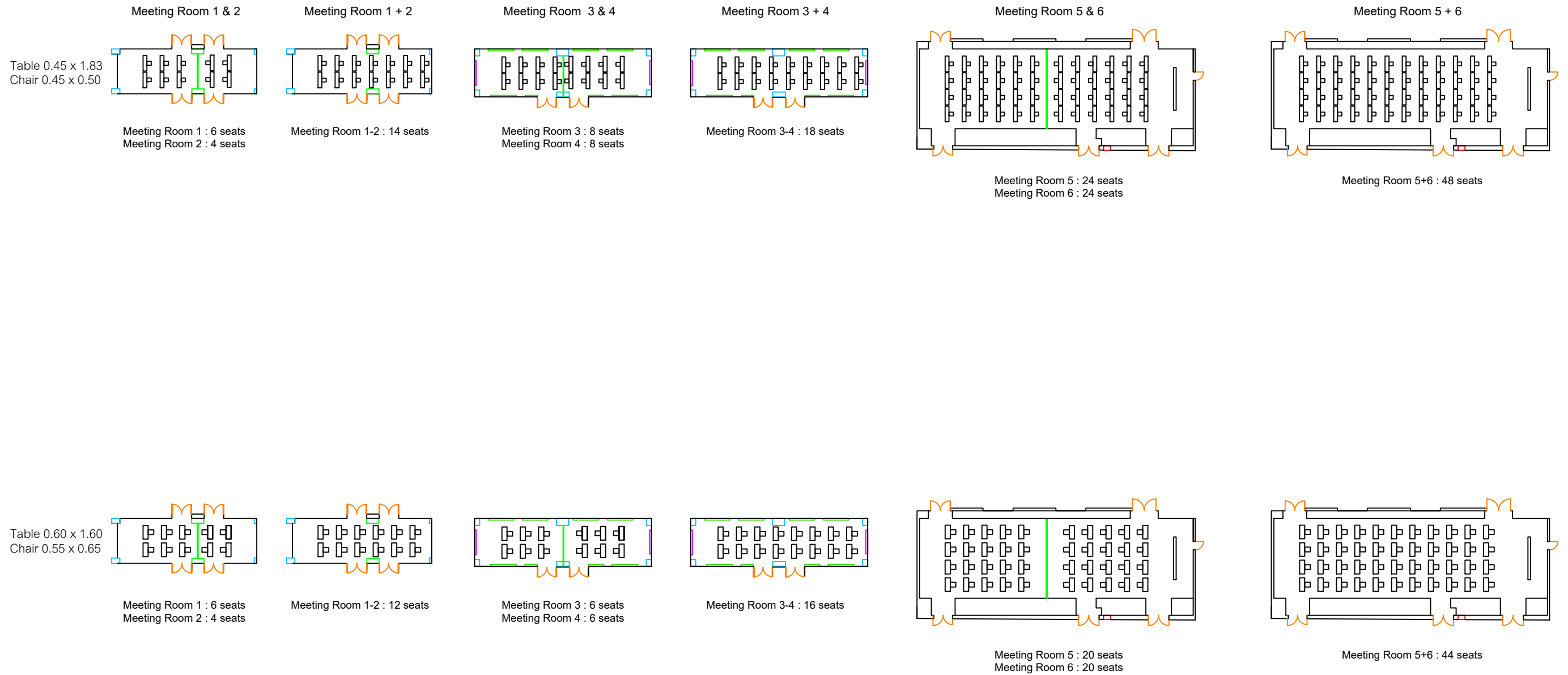

I-Shape

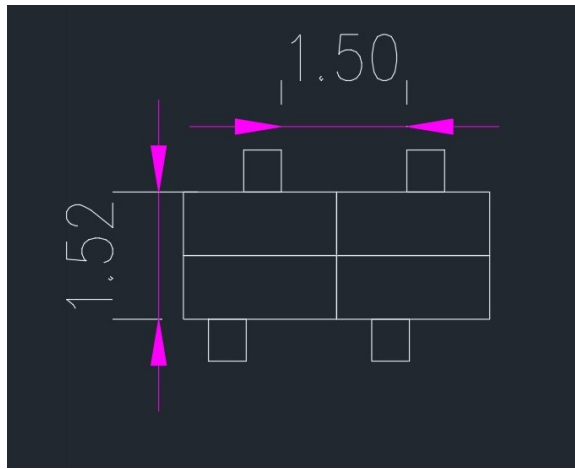

Meeting Room 1 & 2

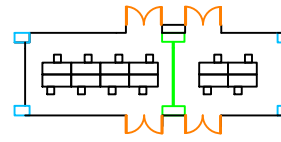

Meeting Room 1 : 8 seats
Meeting Room 2 : 4 seats

Meeting Room 1 + 2

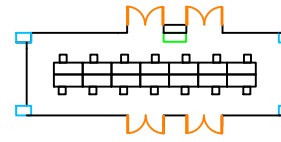

Meeting Room 1-2 : 14 seats

Meeting Room 3 & 4

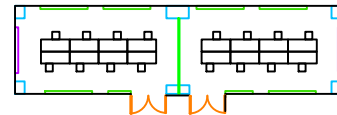

Meeting Room 3 : 8 seats
Meeting Room 4 : 8 seats

Meeting Room 3 + 4

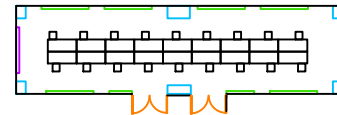

Meeting Room 3-4 : 18 seats

Meeting Room 5 & 6

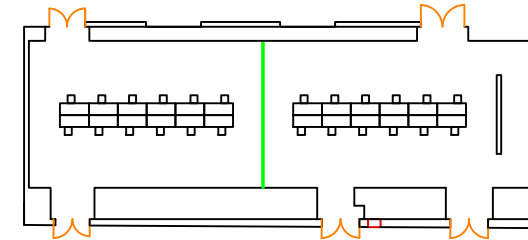

Meeting Room 5 : 12 seats
Meeting Room 6 : 12 seats

Meeting Room 5 + 6

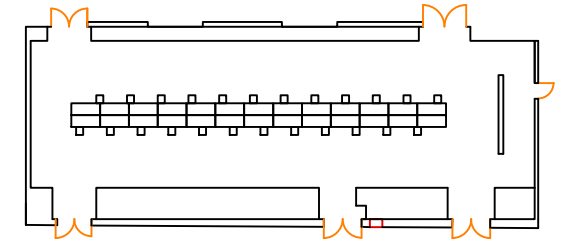

Meeting Room 5+6 : 24 seats

Table 0.76 x 1.83
Chair 0.45 x 0.50

Table 0.60 x 1.60
Chair 0.55 x 0.65

Meeting Room 1 : 6 seats
Meeting Room 2 : 4 seats

Meeting Room 1-2 : 12 seats

Meeting Room 3 : 8 seats
Meeting Room 4 : 8 seats

Meeting Room 3-4 : 18 seats

Meeting Room 5 : 12 seats
Meeting Room 6 : 12 seats

Meeting Room 5+6 : 26 seats

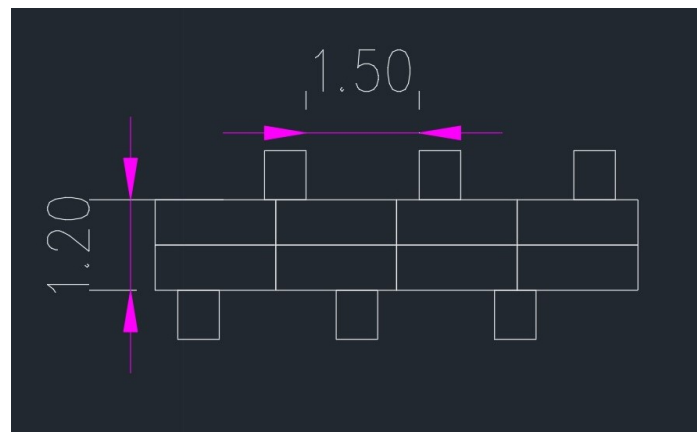

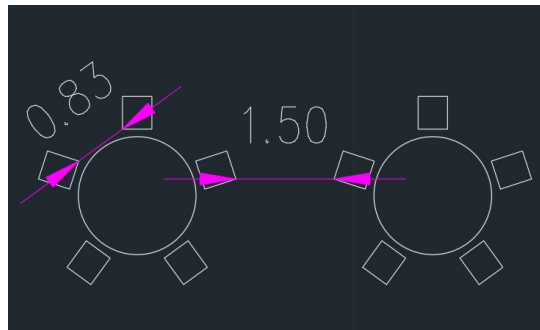

Round Table

Meeting Room 1 & 2

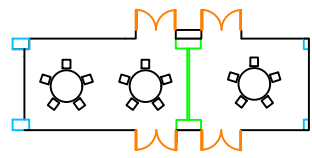

Meeting Room 1 : 10 seats
Meeting Room 2 : 5 seats

Meeting Room 1 + 2

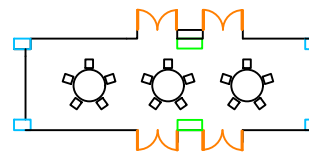

Meeting Room 1-2 : 15 seats

Meeting Room 3 & 4

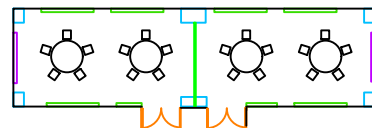

Meeting Room 3 : 10 seats
Meeting Room 4 : 10 seats

Meeting Room 3 + 4

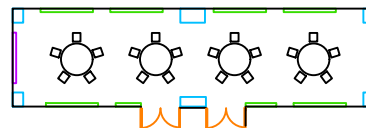

Meeting Room 3-4 : 20 seats

Meeting Room 5 & 6

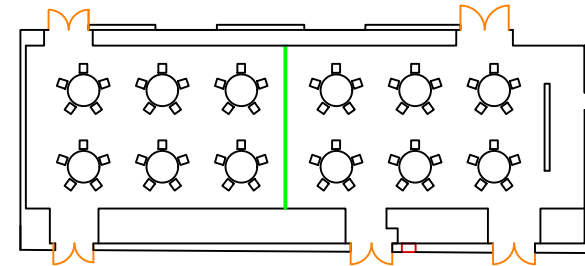

Meeting Room 5 : 30 seats
Meeting Room 6 : 30 seats

Meeting Room 5 + 6

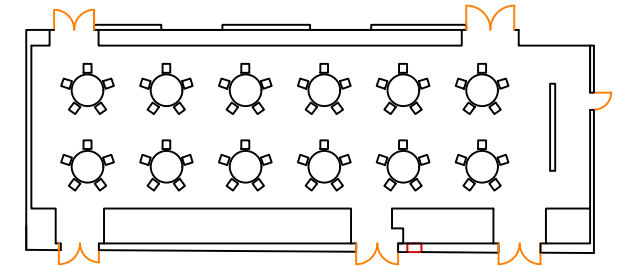

Meeting Room 5+6 : 60 seats

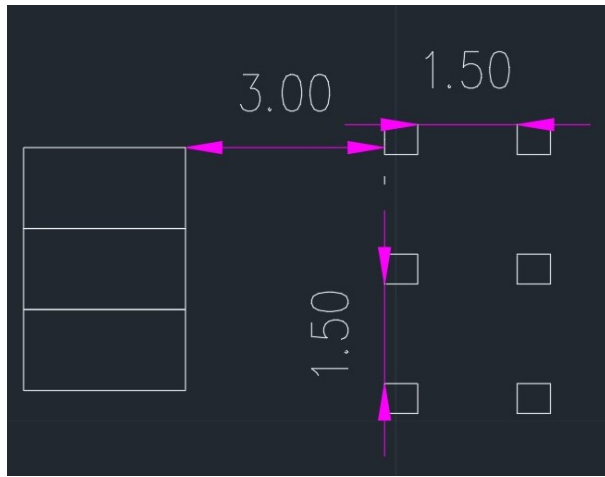

Theatre

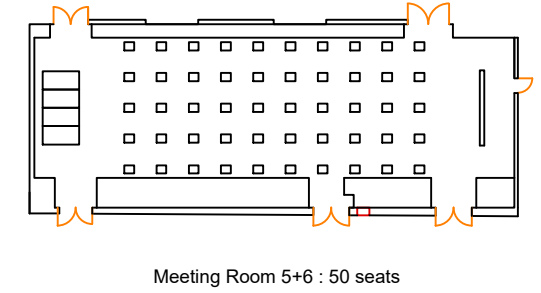
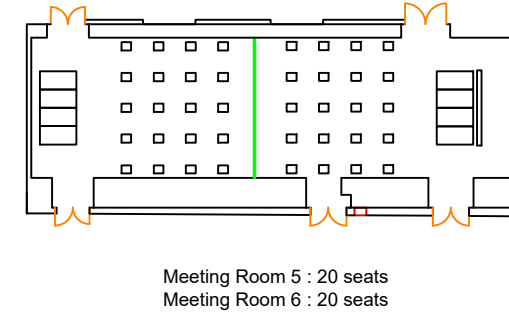
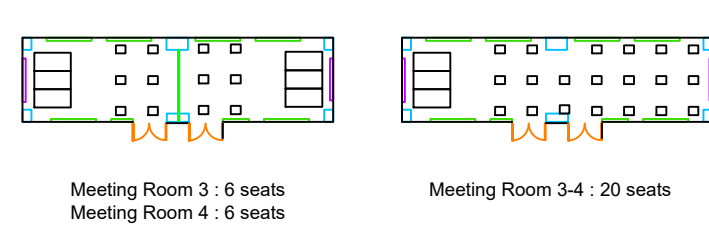
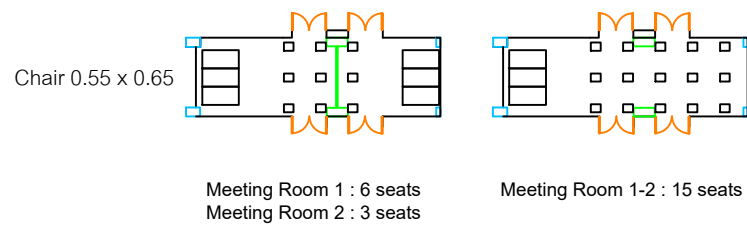
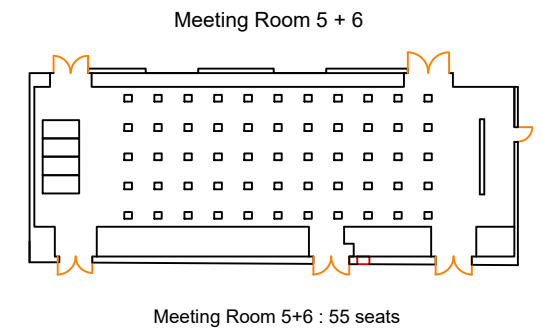
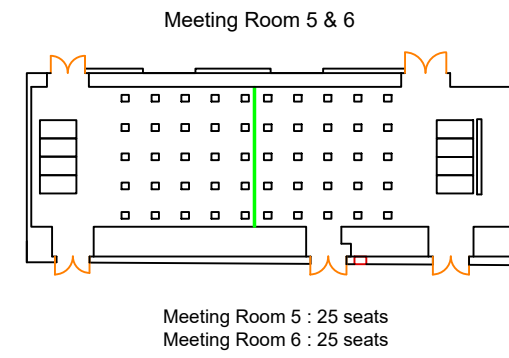
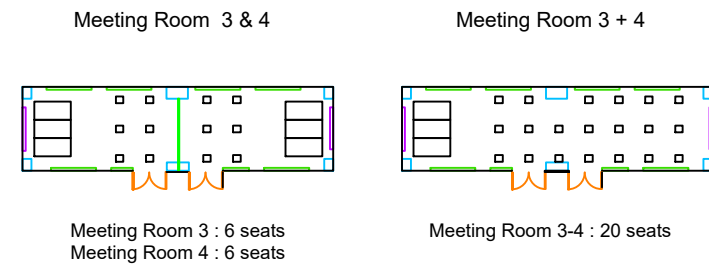
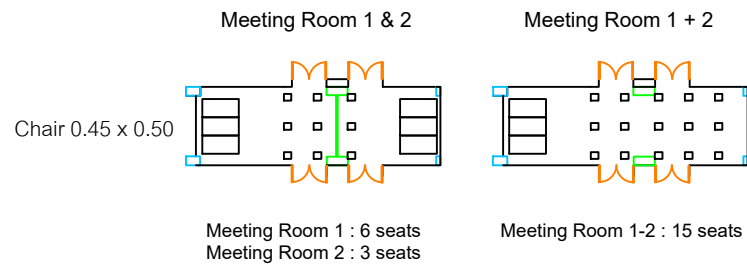

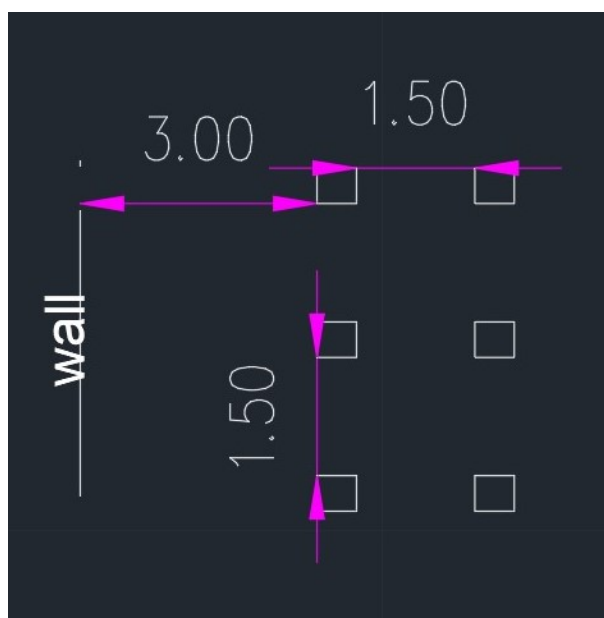

Theatre

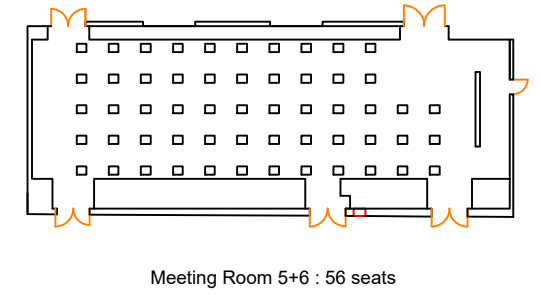
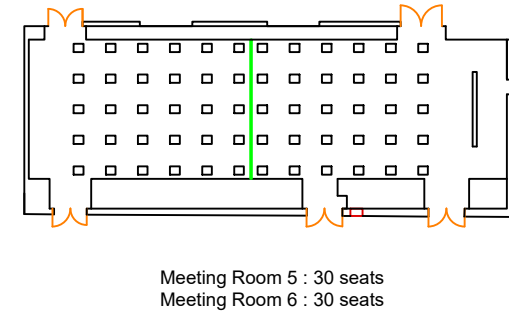
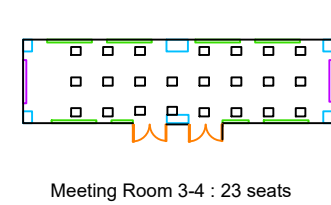
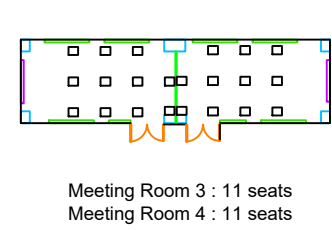
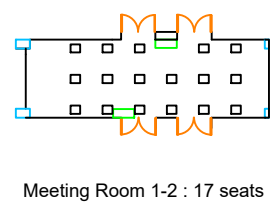
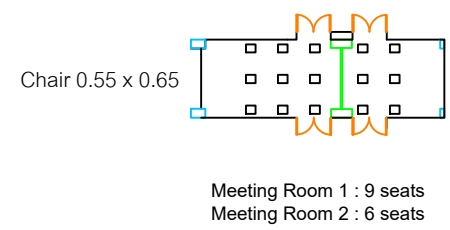
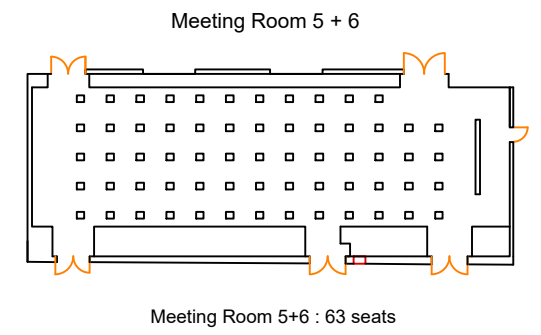
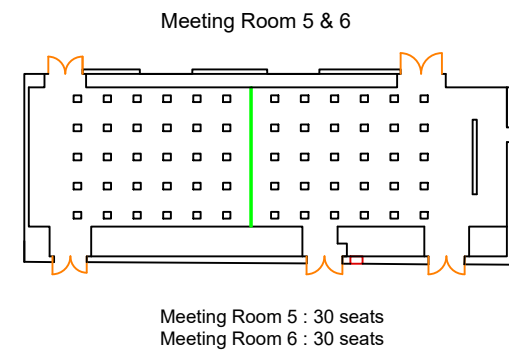
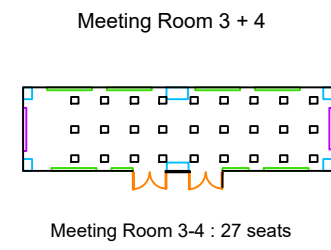
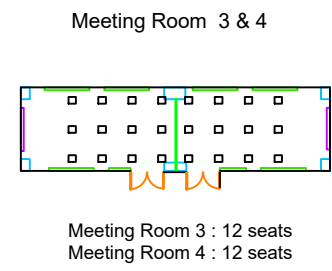
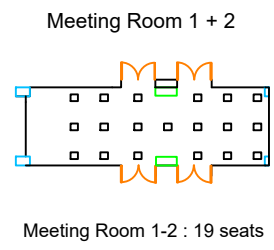
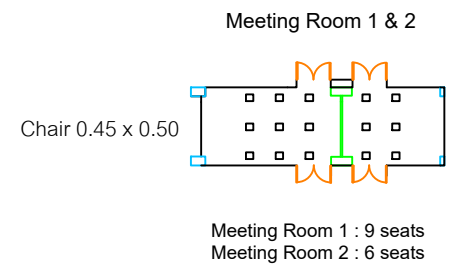

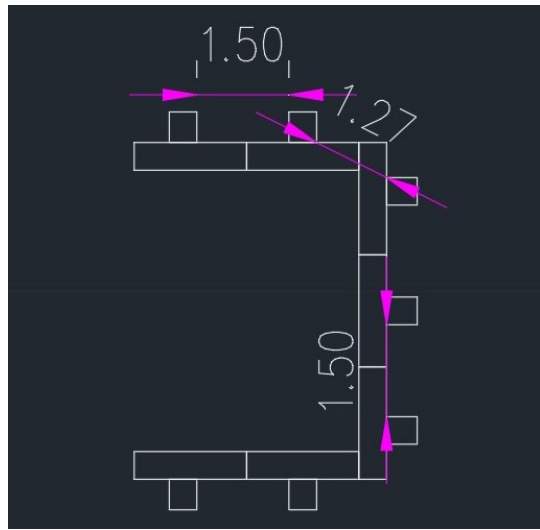

U-Shape

Meeting Room 1 & 2

Table 0.45 x 1.83
Chair 0.45 x 0.50

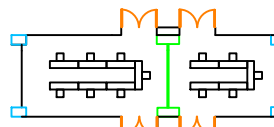

Meeting Room 1 : 7 seats
Meeting Room 2 : 5 seats

Meeting Room 1 + 2

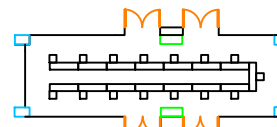

Meeting Room 1-2 : 15 seats

Meeting Room 3 & 4

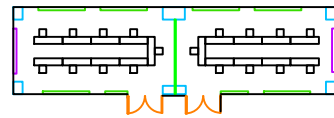

Meeting Room 3 : 9 seats
Meeting Room 4 : 9 seats

Meeting Room 3 + 4

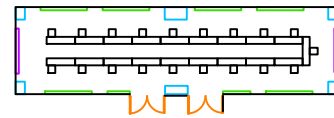

Meeting Room 3-4 : 19 seats

Meeting Room 5 & 6

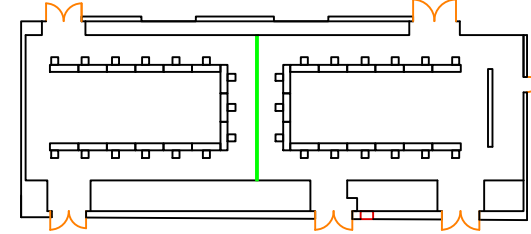

Meeting Room 5 : 15 seats
Meeting Room 6 : 15 seats

Meeting Room 5 + 6

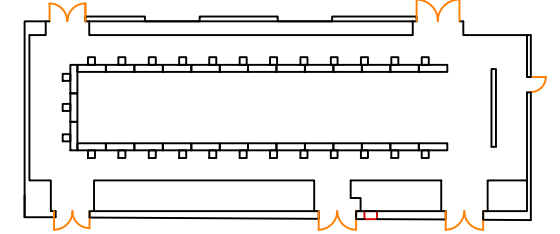

Meeting Room 5+6 : 27 seats

Table 0.60 x 1.60
Chair 0.55 x 0.65

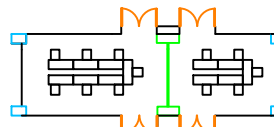

Meeting Room 1 : 7 seats
Meeting Room 2 : 5 seats

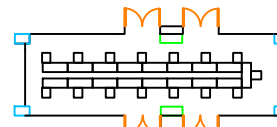

Meeting Room 1-2 : 15 seats

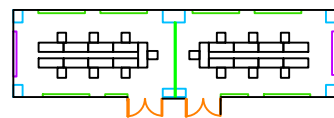

Meeting Room 3 : 7 seats
Meeting Room 4 : 7 seats

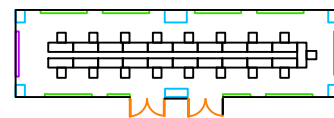

Meeting Room 3-4 : 17 seats

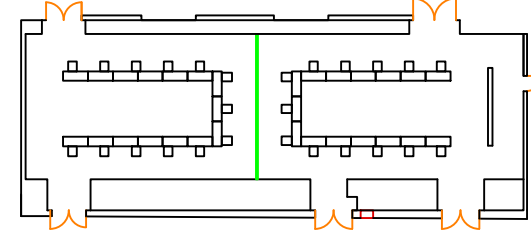

Meeting Room 5 : 13 seats
Meeting Room 6 : 13 seats

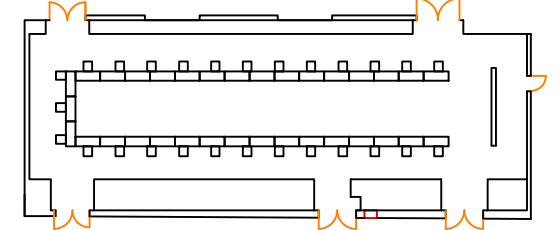

Meeting Room 5+6 : 27 seats

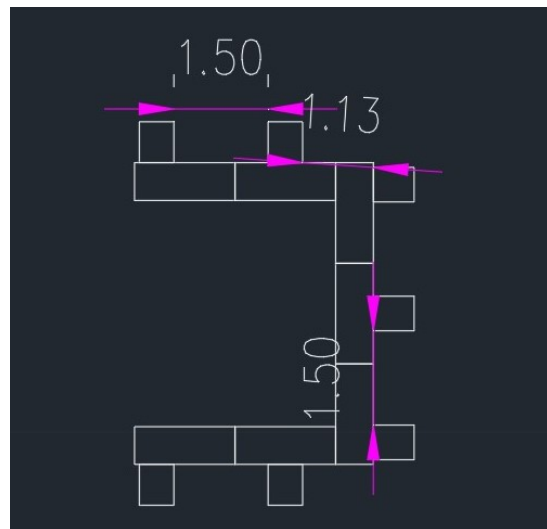

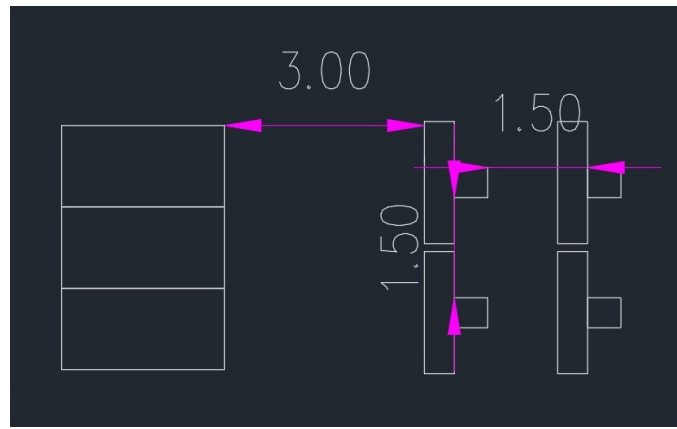

Classroom

